



TDA7563PD

MULTIFUNCTION QUAD POWER AMPLIFIER WITH BUILT-IN DIAGNOSTICS FEATURES

PRODUCT PREVIEW

1 FEATURES

- MULTIPower BCD TECHNOLOGY
- MOSFET OUTPUT POWER STAGE
- DMOS POWER OUTPUT
- NON-SWITCHING HI-EFFICIENCY
- HIGH OUTPUT POWER CAPABILITY 4x28W/4Ω @ 14.4V, 1KHZ, 10% THD, 4x40W EIAJ
- MAX. OUTPUT POWER 4x72W/2Ω
- FULL I²C BUS DRIVING:
 - ST-BY
 - INDEPENDENT FRONT/REAR SOFT PLAY/MUTE
 - SELECTABLE GAIN 30dB
 - 16dB (FOR LOW NOISE LINE OUTPUT FUNCTION)
 - HIGH EFFICIENCY ENABLE/DISABLE
 - I²C BUS DIGITAL DIAGNOSTICS
- FULL FAULT PROTECTION
- DC OFFSET DETECTION
- FOUR INDEPENDENT SHORT CIRCUIT PROTECTION
- CLIPPING DETECTOR PIN WITH SELECTABLE THRESHOLD (2%/10%)
- ST-BY/MUTE PIN
- LINEAR THERMAL SHUTDOWN
- ESD PROTECTION

Figure 1. Package

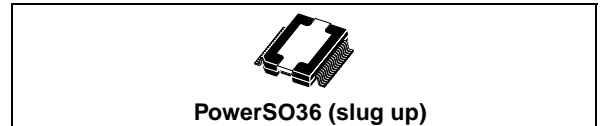

Table 1. Order Codes

| Part Number | Package |
|-------------|---------------------|
| TDA7563PD | PowerSO36 (slug up) |
| TDA7563PDTR | Tape & Reel |

2 DESCRIPTION

The TDA7563PD is a new BCD technology Quad Bridge type of car radio amplifier in PowerSO36 package specially intended for car radio applications. Thanks to the DMOS output stage the TDA7563PD has a very low distortion allowing a clear powerful sound. Among the features, its superior efficiency performance coming from the internal exclusive structure, makes it the most suitable device to simplify the thermal management in high power sets. The dissipated output power under average listening condition is in fact reduced up to 50% when compared to the level provided by conventional class AB solutions. This device is equipped with a full diagnostics array that communicates the status of each speaker through the I²C bus.

Figure 2. Block Diagram

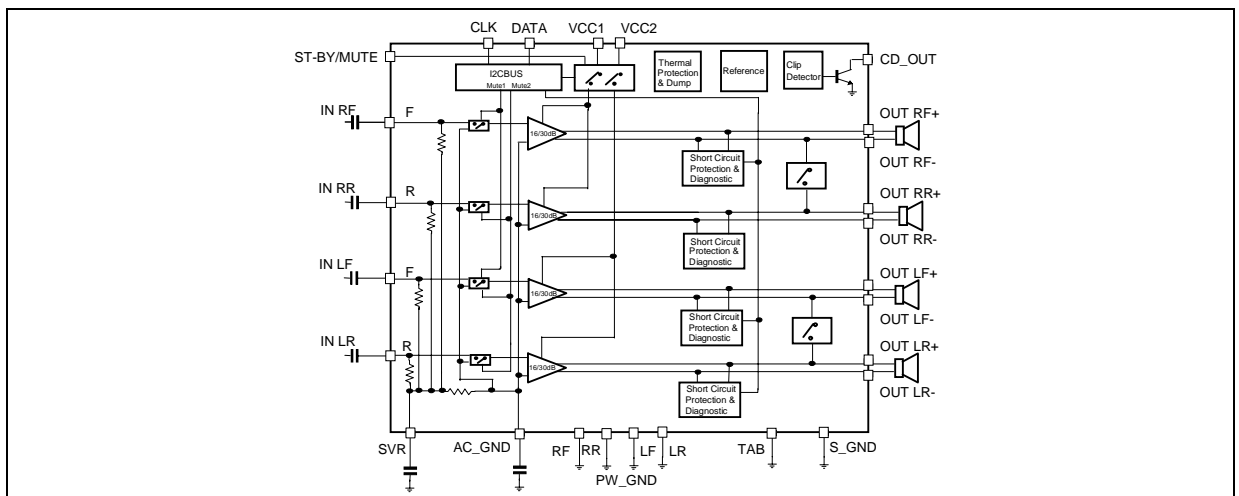

Table 2. Absolute Maximum Ratings

| Symbol | Parameter | Value | Unit |
|-----------------------------------|--|------------|------|
| V _{op} | Operating Supply Voltage | 18 | V |
| V _S | DC Supply Voltage | 28 | V |
| V _{peak} | Peak Supply Voltage (for t = 50ms) | 50 | V |
| V _{CK} | CK pin Voltage | 6 | V |
| V _{DATA} | Data Pin Voltage | 6 | V |
| I _O | Output Peak Current (not repetitive t = 100ms) | 8 | A |
| I _O | Output Peak Current (repetitive f > 10Hz) | 6 | A |
| P _{tot} | Power Dissipation T _{case} = 70°C | 85 | W |
| T _{stg} , T _j | Storage and Junction Temperature | -55 to 150 | °C |

Table 3. Thermal Data

| Symbol | Parameter | Value | Unit |
|------------------------|-------------------------------------|--------|------|
| R _{th j-case} | Thermal Resistance Junction to case | Max. 1 | °C/W |

Figure 3. Pin Connection (Top view)

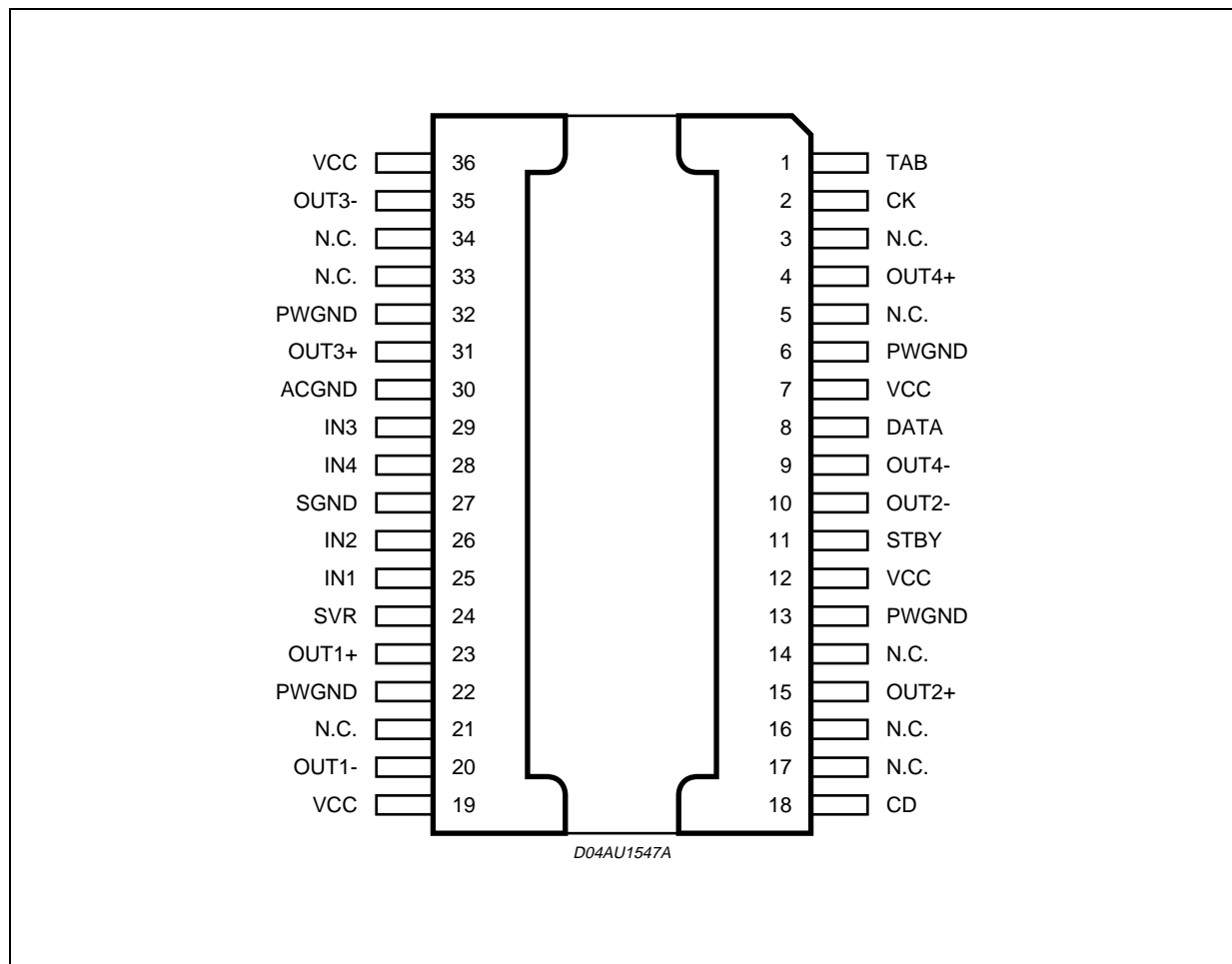

Figure 4. Application Circuit

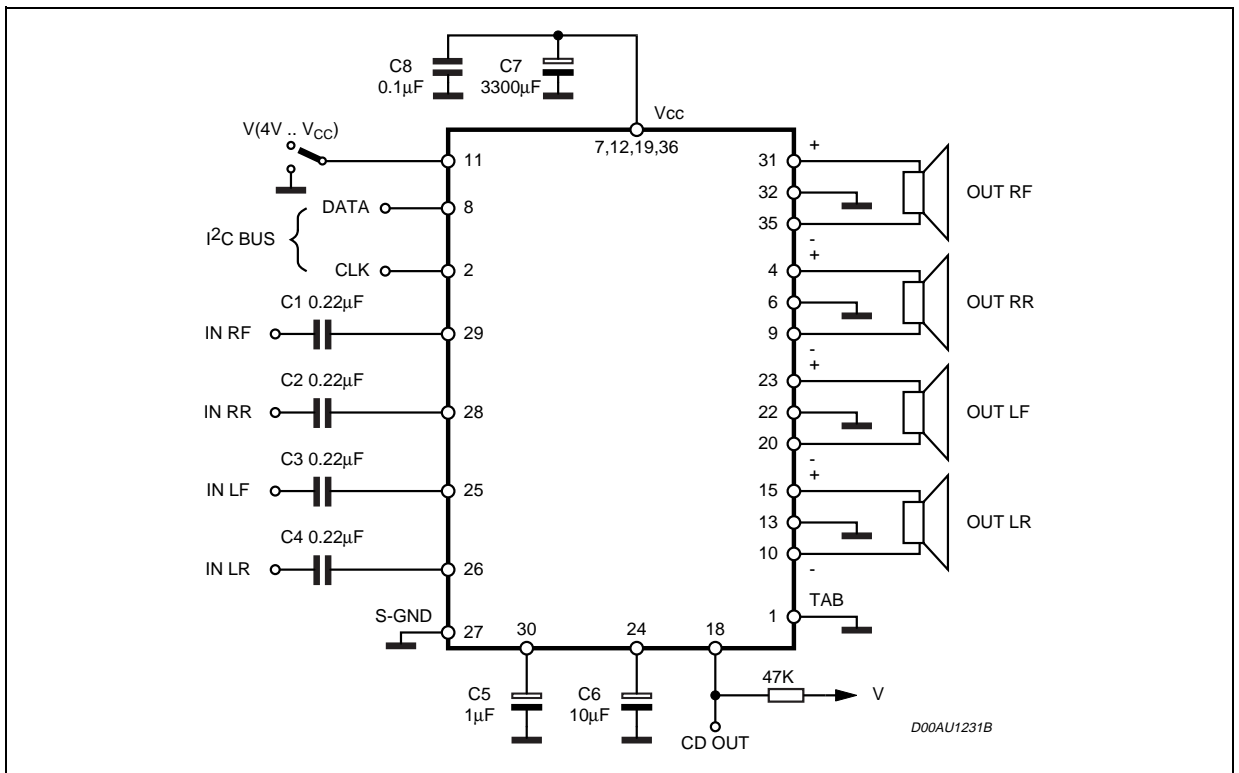

Table 4. Electrical Characteristics

(Refer to the test circuit, $V_S = 14.4V$; $R_L = 4\Omega$; $f = 1KHz$; $G_V = 30dB$; $T_{amb} = 25^\circ C$; unless otherwise specified.)

| Symbol | Parameter | Test Condition | Min. | Typ. | Max. | Unit |
|------------------------|-------------------------------|--|------|------|-------|------------|
| POWER AMPLIFIER | | | | | | |
| V_S | Supply Voltage Range | | 8 | | 18 | V |
| I_d | Total Quiescent Drain Current | | | 170 | 300 | mA |
| P_O | Output Power | EIAJ ($V_S = 13.7V$) | 35 | 40 | | W |
| | | THD = 10% | 25 | 28 | | W |
| | | THD = 1% | | 22 | | W |
| | | $R_L = 2\Omega$; EIAJ ($V_S = 13.7V$) | 55 | 62 | | W |
| | | $R_L = 2\Omega$; THD 10% | 40 | 46 | | W |
| | $R_L = 2\Omega$; THD 1% | | | 35 | | W |
| | $R_L = 2\Omega$; MAX POWER | | | 72 | | W |
| THD | Total Harmonic Distortion | $P_O = 1W$ to $10W$; STD MODE | | 0.03 | 0.1 | % |
| | | HE MODE; $P_O = 1.5W$ | | 0.02 | 0.1 | % |
| | | HE MODE; $P_O = 8W$ | | 0.15 | 0.5 | % |
| | | $P_O = 1-10W$, $f = 10kHz$ | | 0.2 | 0.5 | % |
| | $G_V = 16dB$; STD Mode | | 0.02 | 0.05 | % | |
| | $V_O = 0.1$ to $5VRMS$ | | | | | |
| C_T | Cross Talk | $f = 1KHz$ to $10KHz$, $R_g = 600\Omega$ | 50 | 60 | | dB |
| R_{IN} | Input Impedance | | 60 | 100 | 130 | K Ω |
| G_{V1} | Voltage Gain 1 | | 29.5 | 30 | 30.5 | dB |
| ΔG_{V1} | Voltage Gain Match 1 | | -1 | | 1 | dB |
| G_{V2} | Voltage Gain 2 | | 15.5 | 16 | 16.5 | dB |
| ΔG_{V2} | Voltage Gain Match 2 | | -1 | | 1 | dB |
| E_{IN1} | Output Noise Voltage 1 | $R_g = 600\Omega$ 20Hz to 22kHz | | 50 | 100 | mV |
| E_{IN2} | Output Noise Voltage 2 | $R_g = 600\Omega$; $G_V = 16dB$ 20Hz to 22kHz | | 15 | 30 | mV |
| SVR | Supply Voltage Rejection | $f = 100Hz$ to $10kHz$; $V_r = 1Vpk$; $R_g = 600\Omega$ | 50 | 60 | | dB |
| BW | Power Bandwidth | | 100 | | | KHz |
| A_{SB} | Stand-by Attenuation | | 90 | 110 | | dB |
| I_{SB} | Stand-by Current | | | 2 | 10 | μA |
| A_M | Mute Attenuation | | 80 | 100 | | dB |
| V_{OS} | Offset Voltage | Mute & Play | -100 | 0 | 100 | mV |
| V_{AM} | Min. Supply Mute Threshold | | 7 | 7.5 | 8 | V |
| T_{ON} | Turn ON Delay | D2/D1 (IB1) 0 to 1 | | 5 | 20 | ms |
| T_{OFF} | Turn OFF Delay | D2/D1 (IB1) 1 to 0 | | 5 | 20 | ms |
| V_{SBY} | St-By/Mute pin for St-By | | 0 | | 1.5 | V |
| V_{MU} | St-By/Mute pin for Mute | | 3.5 | | 5 | V |
| V_{OP} | St-By/Mute pin for Operating | | 7 | | V_S | V |
| I_{MU} | St-By/Mute pin Current | $V_{STBY/MUTE} = 8.5V$ | | 20 | 40 | μA |
| | | $V_{STBY/MUTE} < 1.5V$ | | 0 | 10 | μA |
| CD_{LK} | Clip Det High Leakage Current | CD off | | 0 | 15 | μA |
| CD_{SAT} | Clip Det Sat. Voltage | CD on; $I_{CD} = 1mA$ | | 300 | | mV |
| CD_{THD} | Clip Det THD level | D0 (IB1) = 1 | 5 | 10 | 15 | % |

Table 4. Electrical Characteristics (continued)(Refer to the test circuit, $V_S = 14.4V$; $R_L = 4\Omega$; $f = 1KHz$; $G_V = 30dB$; $T_{amb} = 25^\circ C$; unless otherwise specified.)

| Symbol | Parameter | Test Condition | Min. | Typ. | Max. | Unit |
|---|--|--|-----------|---------|-----------|----------|
| | | D0 (IB1) = 0 | 1 | 2 | 3 | % |
| TURN ON DIAGNOSTICS 1 (Power Amplifier Mode) | | | | | | |
| Pgnd | Short to GND det. (below this limit, the Output is considered in Short Circuit to GND) | Power Amplifier in st-by | | | 1.2 | V |
| Pvs | Short to Vs det. (above this limit, the Output is considered in Short Circuit to VS) | | Vs -1.2 | | | V |
| Pnop | Normal operation thresholds. (Within these limits, the Output is considered without faults). | | 1.8 | | Vs -1.8 | V |
| Lsc | Shorted Load det. | | | | 0.5 | Ω |
| Lop | Open Load det. | | 130 | | | Ω |
| Lnop | Normal Load det. | | 1.5 | | 70 | Ω |
| TURN ON DIAGNOSTICS 2 (Line Driver Mode) | | | | | | |
| Pgnd | Short to GND det. (below this limit, the Output is considered in Short Circuit to GND) | Power Amplifier in st-by | | | 1.2 | V |
| Pvs | Short to Vs det. (above this limit, the Output is considered in Short Circuit to VS) | | Vs -1.2 | | | V |
| Pnop | Normal operation thresholds. (Within these limits, the Output is considered without faults). | | 1.8 | | Vs -1.8 | V |
| Lsc | Shorted Load det. | | | | 1.5 | Ω |
| Lop | Open Load det. | | 400 | | | Ω |
| Lnop | Normal Load det. | | 4.5 | | 200 | Ω |
| PERMANENT DIAGNOSTICS 2 (Power Amplifier Mode or Line Driver Mode) | | | | | | |
| Pgnd | Short to GND det. (below this limit, the Output is considered in Short Circuit to GND) | Power Amplifier in Mute or Play, one or more short circuits protection activated | | | 1.2 | V |
| Pvs | Short to Vs det. (above this limit, the Output is considered in Short Circuit to VS) | | Vs -1.2 | | | V |
| Pnop | Normal operation thresholds. (Within these limits, the Output is considered without faults). | | 1.8 | | Vs -1.8 | V |
| L _{SC} | Shorted Load Det. | Pow. Amp. mode | | | 0.5 | Ω |
| | | Line Driver mode | | | 1.5 | Ω |
| V _O | Offset Detection | Power Amplifier in play, AC Input signals = 0 | ± 1.5 | ± 2 | ± 2.5 | V |
| I²C BUS INTERFACE | | | | | | |
| SCL | Clock Frequency | | | | 400 | KHz |
| V _{IL} | Input Low Voltage | | | | 1.5 | V |
| V _{IH} | Input High Voltage | | 2.3 | | | V |

Figure 5. Quiescent Current vs. Supply Voltage

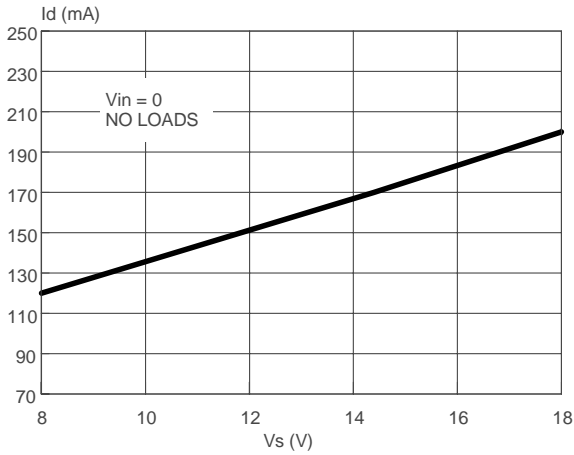

Figure 8. Distortion vs. Output Power (4Ω, STD)

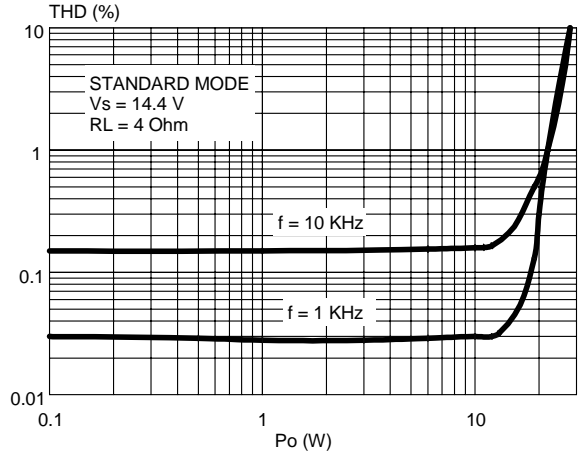

Figure 6. Output Power vs. Supply Voltage (4Ω)

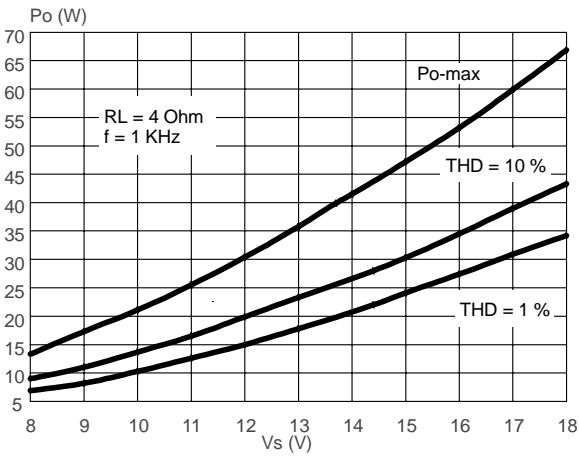

Figure 9. Distortion vs. Output Power (4Ω, HI-EFF)

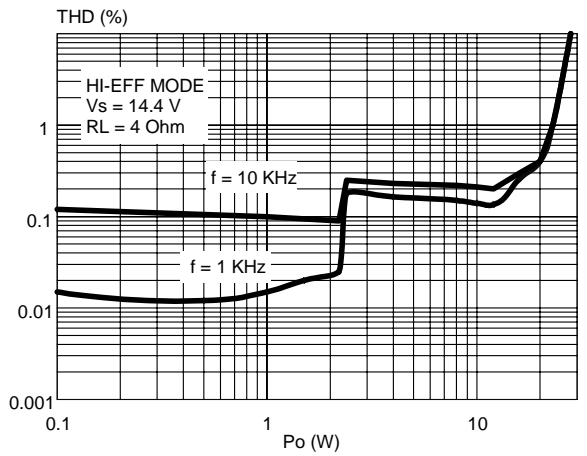

Figure 7. Output Power vs. Supply Voltage (2Ω)

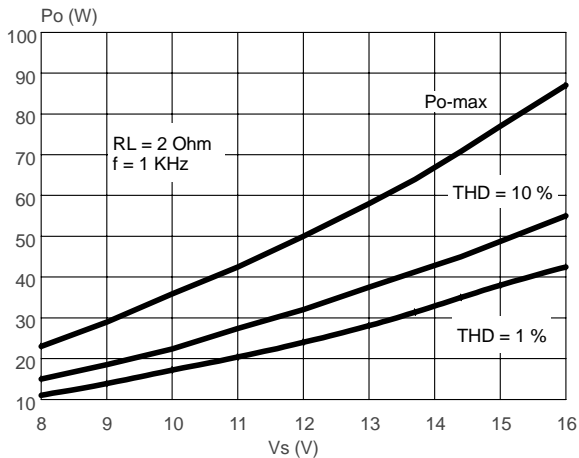

Figure 10. Distortion vs. Output Power (2Ω, STD)

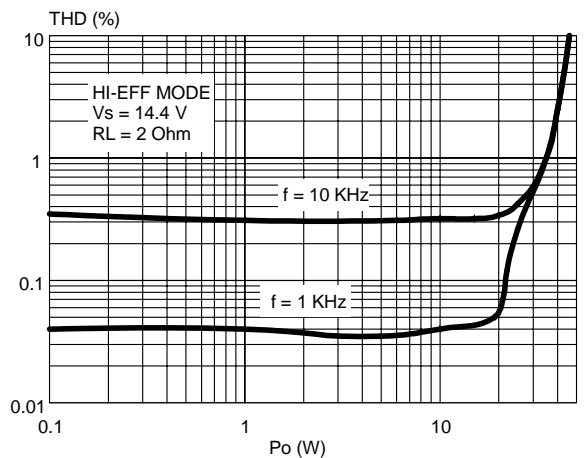

Figure 11. Distortion vs. Frequency (4Ω)

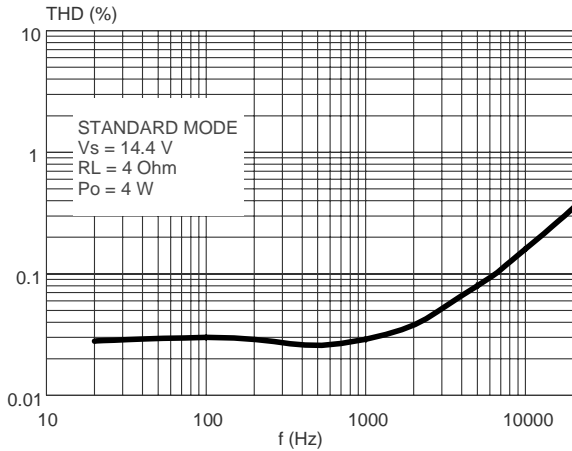

Figure 14. Supply Voltage Rejection vs. Freq.

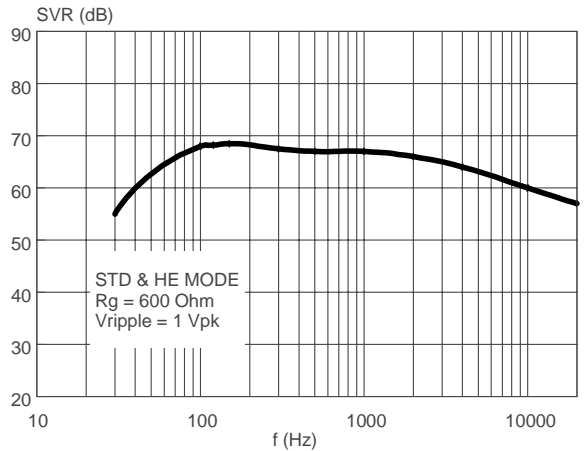

Figure 12. Distortion vs. Frequency (2Ω)

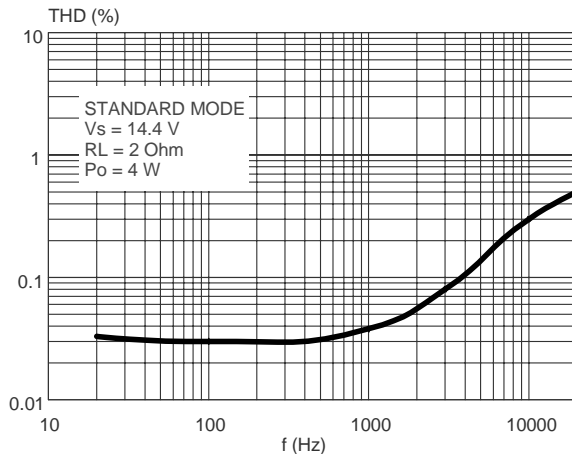

Figure 15. Power Dissipation & Efficiency vs. Output Power (4Ω, STD, SINE)

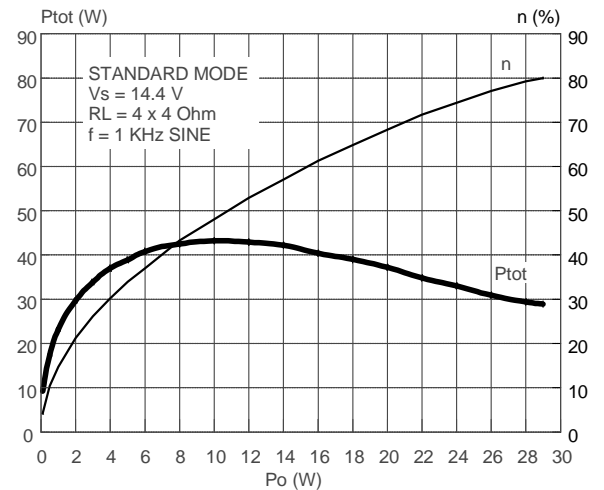

Figure 13. Crosstalk vs. Frequency

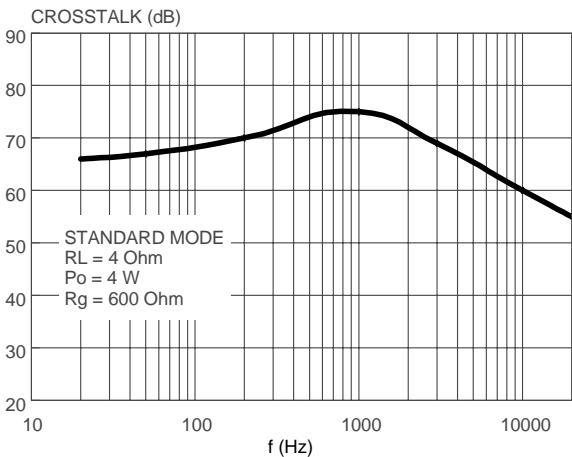

Figure 16. Power Dissipation & Efficiency vs. Output Power (4W, HI-EFF, SINE)

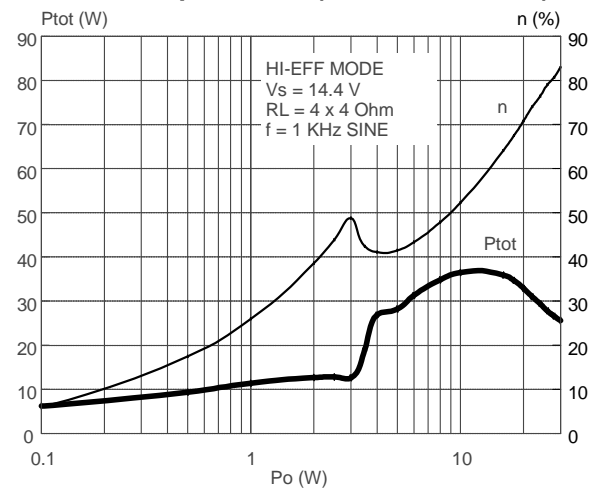

Figure 17. Power Dissipation vs. Average Output Power (Audio Program Simulation, 4Ω)

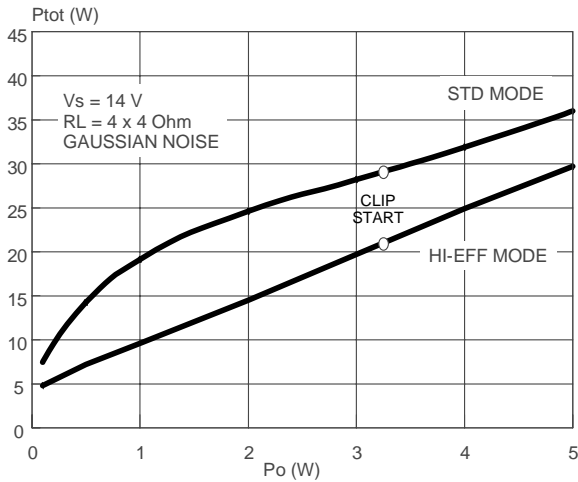
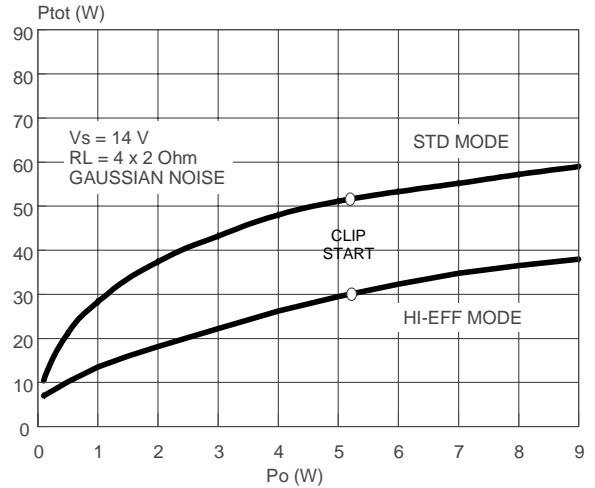

Figure 18. Power Dissipation vs. Average Output Power (Audio Program Simulation, 2Ω)



3 Diagnostics Functional Description:

a) TURN-ON DIAGNOSTIC

It is activated at the turn-on (stand-by out) under I²Cbus request. Detectable output faults are:

- SHORT TO GND
- SHORT TO Vs
- SHORT ACROSS THE SPEAKER
- OPEN SPEAKER

To verify if any of the above misconnections are in place, a subsonic (inaudible) current pulse (fig. 19) is internally generated, sent through the speaker(s) and sunk back. The Turn On diagnostic status is internally stored until a successive diagnostic pulse is requested (after a I2C reading).

If the "stand-by out" and "diag. enable" commands are both given through a single programming step, the pulse takes place first (power stage still in stand-by mode, low, outputs= high impedance).

Afterwards, when the Amplifier is biased, the PERMANENT diagnostic takes place. The previous Turn On state is kept until a short appears at the outputs.

Figure 19. Turn - On diagnostic: working principle

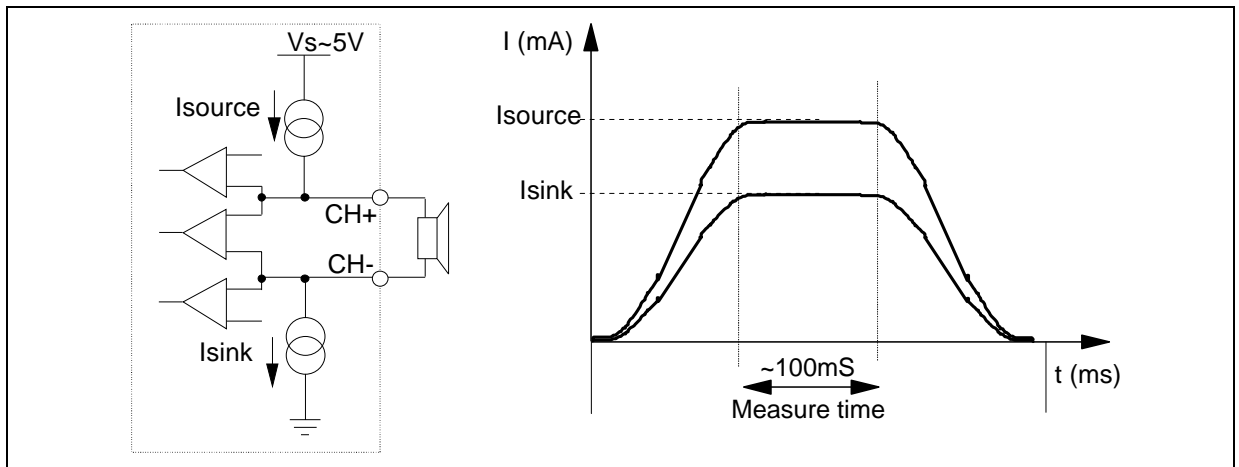

Fig. 20 and 21 show SVR and OUTPUT waveforms at the turn-on (stand-by out) with and without TURN-ON DIAGNOSTIC.

Figure 20. SVR and Output behaviour (CASE 1: without turn-on diagnostic)

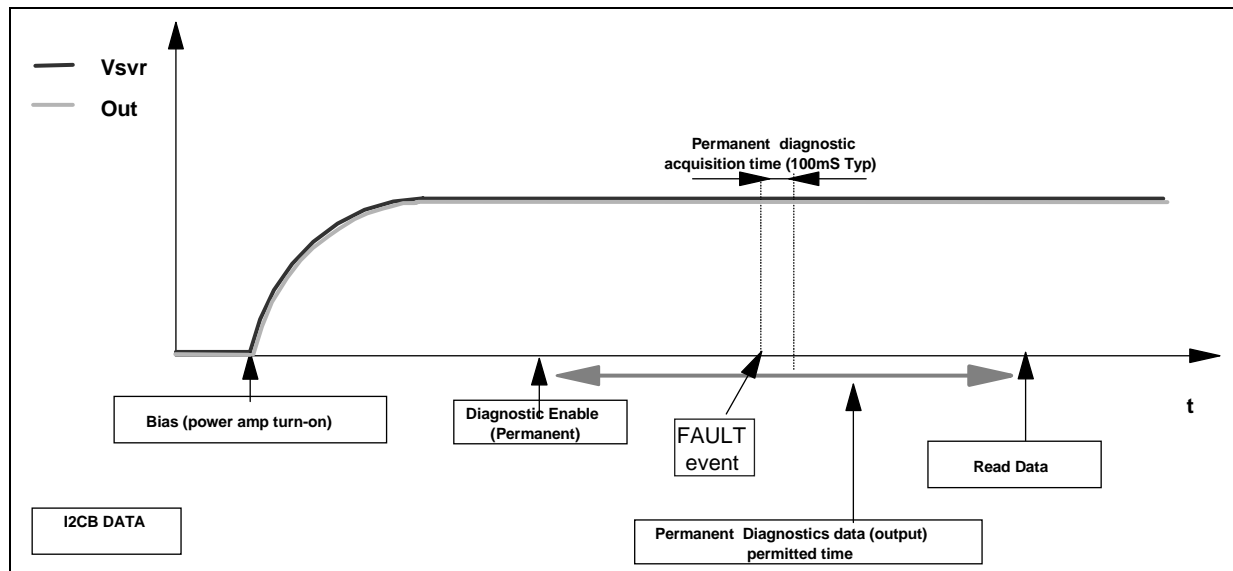
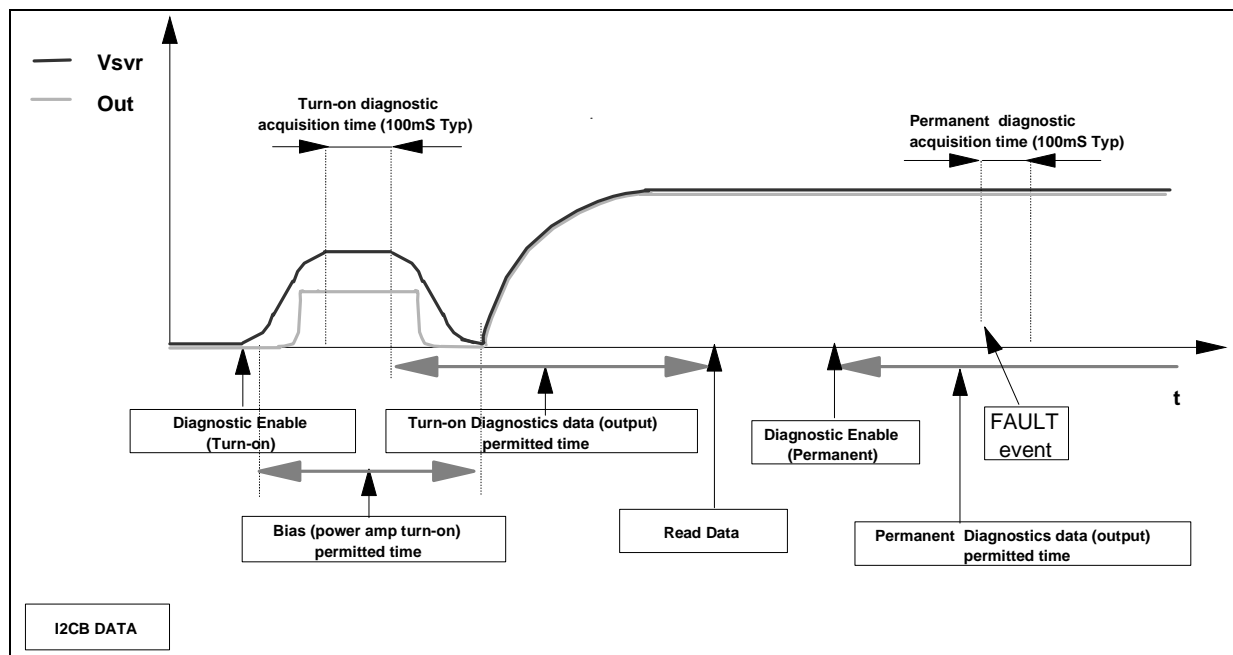
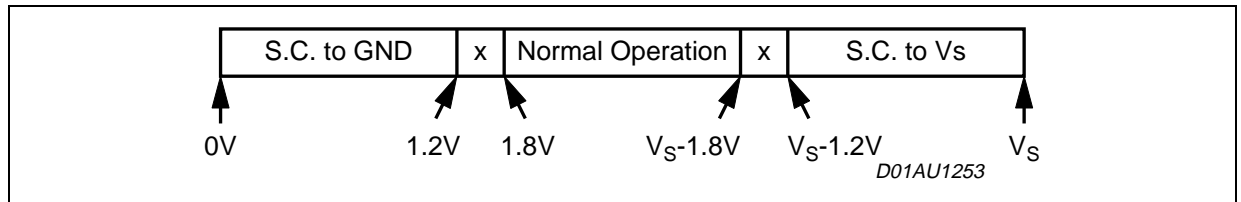

Figure 21. SVR and Output pin behaviour (CASE 2: with turn-on diagnostic)



The information related to the outputs status is read and memorized at the end of the current pulse top. The acquisition time is 100 ms (typ.). No audible noise is generated in the process. As for SHORT TO GND / Vs the fault-detection thresholds remain unchanged from 30 dB to 16 dB gain setting. They are as follows:

Figure 22.



Concerning SHORT ACROSS THE SPEAKER / OPEN SPEAKER, the threshold varies from 30 dB to 16 dB gain setting, since different loads are expected (either normal speaker's impedance or high impedance). The values in case of 30 dB gain are as follows:

Figure 23.

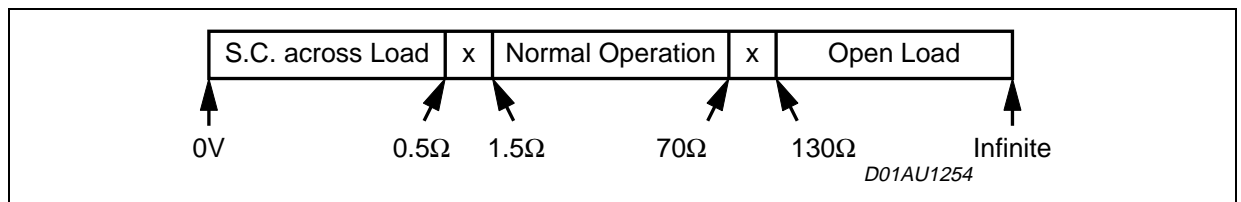

If the Line-Driver mode ($G_v = 16$ dB and Line Driver Mode diagnostic = 1) is selected, the same thresholds will change as follows:

Figure 24.

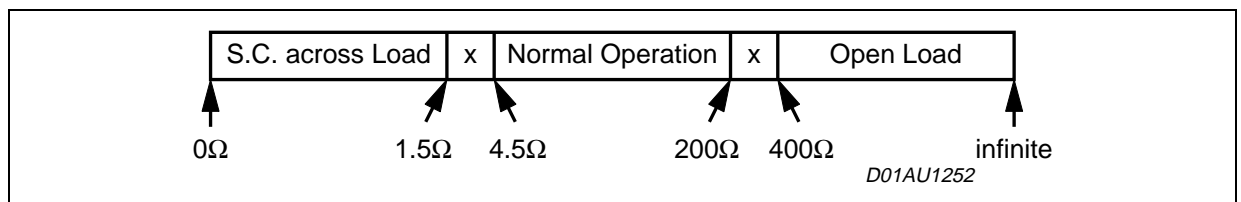

b) PERMANENT DIAGNOSTICS.

Detectable conventional faults are:

- SHORT TO GND
- SHORT TO Vs
- SHORT ACROSS THE SPEAKER

The following additional features are provided:

- OUTPUT OFFSET DETECTION

The TDA7563PD has 2 operating statuses:

1 RESTART mode. The diagnostic is not enabled. Each audio channel operates independently from each other. If any of the a.m. faults occurs, only the channel(s) interested is shut down. A check of the output status is made every 1 ms (fig. 25). Restart takes place when the overload is removed.

2 DIAGNOSTIC mode. It is enabled via I²C bus and self activates if an output overload (such to cause the intervention of the short-circuit protection) occurs to the speakers outputs . Once activated, the diagnostics procedure develops as follows (fig. 26):

- To avoid momentary re-circulation spikes from giving erroneous diagnostics, a check of the output status is made after 1ms: if normal situation (no overloads) is detected, the diagnostic is not performed and the channel returns back active.
- Instead, if an overload is detected during the check after 1 ms, then a diagnostic cycle having a duration of about 100 ms is started.
- After a diagnostic cycle, the audio channel interested by the fault is switched to RESTART mode. The relevant data are stored inside the device and can be read by the microprocessor. When one cycle has terminated, the next one is activated by an I²C reading. This is to ensure continuous diagnostics throughout the car-radio operating time.
- To check the status of the device a sampling system is needed. The timing is chosen at microprocessor level (over half a second is recommended).

Figure 25. Restart timing without Diagnostic Enable (Permanent) - Each 1mS time, a sampling of the fault is done

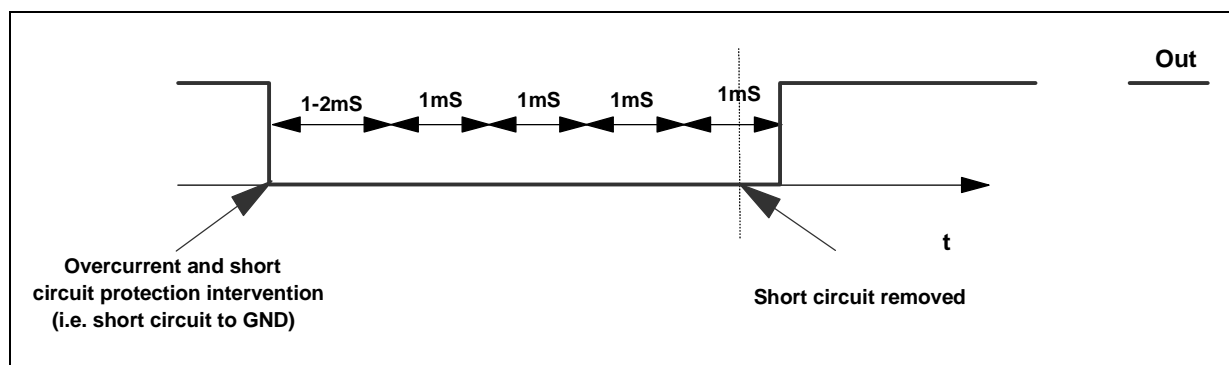
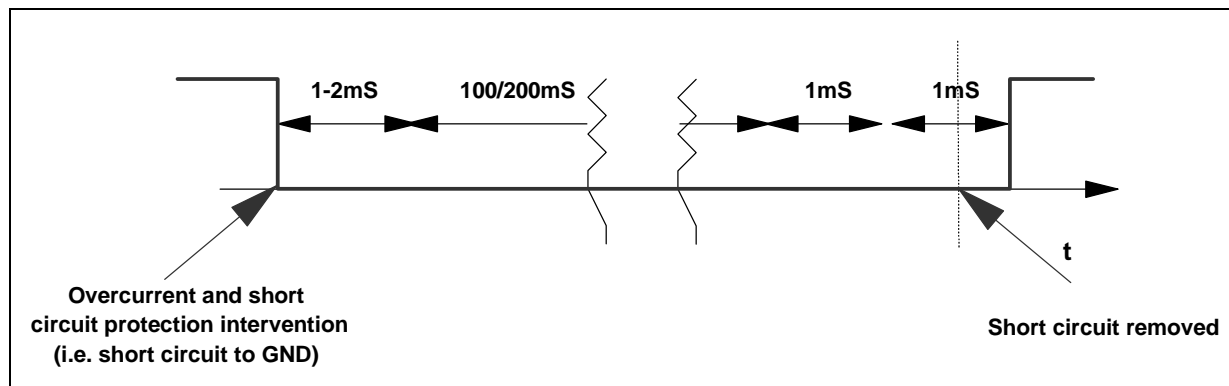

Figure 26. Restart timing with Diagnostic Enable (Permanent)



4 OUTPUT DC OFFSET DETECTION

Any DC output offset exceeding ± 2 V are signalled out. This inconvenient might occur as a consequence of initially defective or aged and worn-out input capacitors feeding a DC component to the inputs, so putting the speakers at risk of overheating.

This diagnostic has to be performed with low-level output AC signal (or $V_{in} = 0$).

The test is run with selectable time duration by microprocessor (from a "start" to a "stop" command):

- START = Last reading operation or setting IB1 - D5 - (OFFSET enable) to 1
- STOP = Actual reading operation

Excess offset is signalled out if persistent throughout the assigned testing time. This feature is disabled if any overloads leading to activation of the short-circuit protection occurs in the process.

5 MULTIPLE FAULTS

When more misconnections are simultaneously in place at the audio outputs, it is guaranteed that at least one of them is initially read out. The others are notified after successive cycles of I²C reading and faults removal, provided that the diagnostic is enabled. This is true for both kinds of diagnostic (Turn on and Permanent).

The table below shows all the couples of double-fault possible. It should be taken into account that a short circuit with the 4 ohm speaker unconnected is considered as double fault.

Table 5.

| Double fault table for Turn On Diagnostic | | | | | |
|---|-------------|-------------|----------------|--------------|-------------|
| | S. GND (so) | S. GND (sk) | S. Vs | S. Across L. | Open L. |
| S. GND (so) | S. GND | S. GND | S. Vs + S. GND | S. GND | S. GND |
| S. GND (sk) | / | S. GND | S. Vs | S. GND | Open L. (*) |
| S. Vs | / | / | S. Vs | S. Vs | S. Vs |
| S. Across L. | / | / | / | S. Across L. | N.A. |
| Open L. | / | / | / | / | Open L. (*) |

S. GND (so) / S. GND (sk) in the above table make a distinction according to which of the 2 outputs is shorted to ground (test-current source side= so, test-current sink side = sk). More precisely, in Channels LF and RR, so = CH+, sk = CH-; in Channels LR and RF, so = CH-, sk = CH+ .

In Permanent Diagnostic the table is the same, with only a difference concerning Open Load(*) , which is not among the recognisable faults. Should an Open Load be present during the device's normal working, it would be detected at a subsequent Turn on Diagnostic cycle (i.e. at the successive Car Radio Turn on).

6 FAULTS AVAILABILITY

All the results coming from I²Cbus, by read operations, are the consequence of measurements inside a defined period of time. If the fault is stable throughout the whole period, it will be sent out.

To guarantee always resident functions, every kind of diagnostic cycles (Turn on, Permanent, Offset) will be reactivate after any I²C reading operation. So, when the micro reads the I²C, a new cycle will be able to start, but the read data will come from the previous diag. cycle (i.e. The device is in Turn On state, with a short to Gnd, then the short is removed and micro reads I²C. The short to Gnd is still present in bytes, because it is the result of the previous cycle. If another I²C reading operation occurs, the bytes do not show the short). In general to observe a change in Diagnostic bytes, two I²C reading operations are necessary.

7 THERMAL PROTECTION

Thermal protection is implemented through thermal foldback (fig. 27). Thermal foldback begins limiting the audio input to the amplifier stage as the junction temperatures rise above the normal operating range. This effectively limits the output power capability of the device thus reducing the temperature to acceptable levels without totally interrupting the operation of the device. The output power will decrease to the point at which thermal equilibrium is reached. Thermal equilibrium will be reached when the reduction in output power reduces the dissipated power such that the die temperature falls below the thermal foldback threshold. Should the device cool, the audio level will increase until a new thermal equilibrium is reached or the amplifier reaches full power. Thermal foldback will reduce the audio output level in a linear manner.

Figure 27. Thermal Foldback Diagram

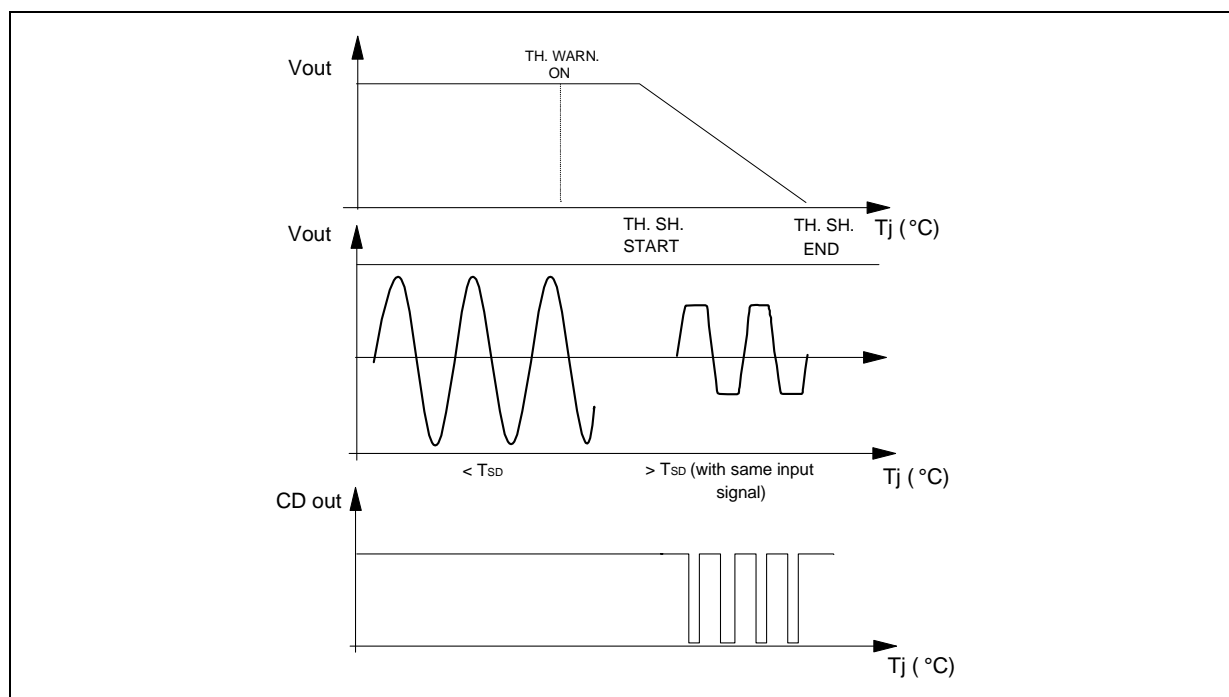

8 I²C PROGRAMMING/READING SEQUENCES

A correct turn on/off sequence respectful of the diagnostic timings and producing no audible noises could be as follows (after battery connection):

TURN-ON: PIN2 > 7V --- 10ms --- (STAND-BY OUT + DIAG ENABLE) --- 500 ms (min) --- MUTING OUT

TURN-OFF: MUTING IN --- 20 ms --- (DIAG DISABLE + STAND-BY IN) --- 10ms --- PIN2 = 0

Car Radio Installation: PIN2 > 7V --- 10ms DIAG ENABLE (write) --- 200 ms --- I²C read (repeat until All faults disappear).

OFFSET TEST: Device in Play (no signal) -- OFFSET ENABLE - 30ms - I²C reading (repeat I²C reading until high-offset message disappears).

9 I²C BUS INTERFACE

Data transmission from microprocessor to the TDA7563PD and viceversa takes place through the 2 wires I²C BUS interface, consisting of the two lines SDA and SCL (pull-up resistors to positive supply voltage must be connected).

9.1 Data Validity

As shown by fig. 28, the data on the SDA line must be stable during the high period of the clock. The HIGH and LOW state of the data line can only change when the clock signal on the SCL line is LOW.

9.2 Start and Stop Conditions

As shown by fig. 29 a start condition is a HIGH to LOW transition of the SDA line while SCL is HIGH. The stop condition is a LOW to HIGH transition of the SDA line while SCL is HIGH.

9.3 Byte Format

Every byte transferred to the SDA line must contain 8 bits. Each byte must be followed by an acknowledge bit. The MSB is transferred first.

9.4 Acknowledge

The transmitter* puts a resistive HIGH level on the SDA line during the acknowledge clock pulse (see fig. 30). The receiver** the acknowledges has to pull-down (LOW) the SDA line during the acknowledge clock pulse, so that the SDA line is stable LOW during this clock pulse.

* Transmitter

- master (μ P) when it writes an address to the TDA7563PD
- slave (TDA7563PD) when the μ P reads a data byte from TDA7563PD

** Receiver

- slave (TDA7563PD) when the μ P writes an address to the TDA7563PD
- master (μ P) when it reads a data byte from TDA7563PD

Figure 28. Data Validity on the I²CBUS

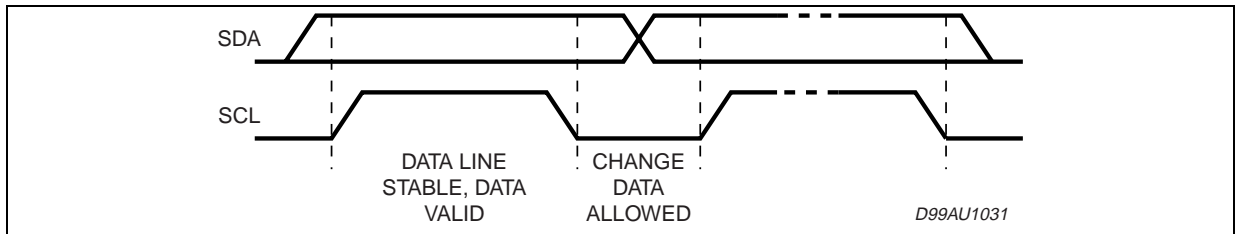

Figure 29. Timing Diagram on the I²CBUS

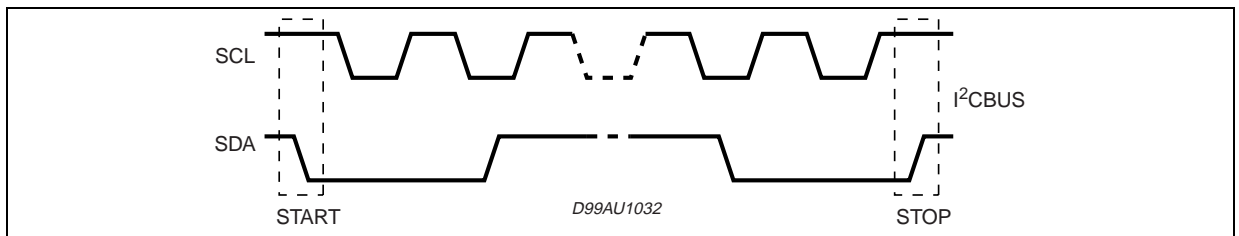
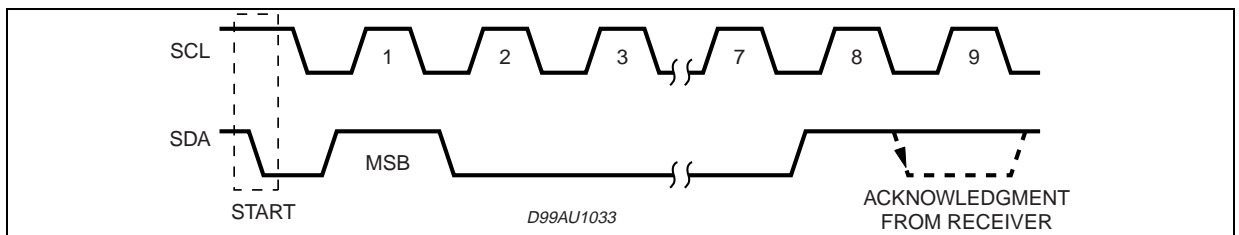

Figure 30. Acknowledge on the I²CBUS



10 SOFTWARE SPECIFICATIONS

All the functions of the TDA7563PD are activated by I²C interface.

The bit 0 of the "ADDRESS BYTE" defines if the next bytes are write instruction (from μ P to TDA7563PD) or read instruction (from TDA7563PD to μ P).

Chip Address:

| D7 | 1 | 1 | 0 | 1 | 1 | 0 | 0 | D0 | X | D8 Hex |
|----|---|---|---|---|---|---|---|----|---|--------|
| | 1 | 1 | 0 | 1 | 1 | 0 | 0 | | X | |

X = 0 Write to device

X = 1 Read from device

If R/W = 0, the μ P sends 2 "Instruction Bytes": IB1 and IB2.

Table 6. IB1

| | |
|----|--|
| D7 | X |
| D6 | Diagnostic enable (D6 = 1) Diagnostic defeat (D6 = 0) |
| D5 | Offset Detection enable (D5 = 1) Offset Detection defeat (D5 = 0) |
| D4 | Front Channel Gain = 30dB (D4 = 0) Gain = 16dB (D4 = 1) |
| D3 | Rear Channel Gain = 30dB (D3 = 0) Gain = 16dB (D3 = 1) |
| D2 | Mute front channels (D2 = 0) Unmute front channels (D2 = 1) |
| D1 | Mute rear channels (D1 = 0) Unmute rear channels (D1 = 1) |
| D0 | CD 2% (D0 = 0) CD 10% (D0 = 1) |

Table 7. IB2

| | |
|----|--|
| D7 | X |
| D6 | used for testing |
| D5 | used for testing |
| D4 | Stand-by on - Amplifier not working - (D4 = 0) Stand-by off - Amplifier working - (D4 = 1) |
| D3 | Power amplifier mode diagnostic (D3 = 0) Line driver mode diagnostic (D3 = 1) |
| D2 | X |
| D1 | Right Channel Power amplifier working in standard mode (D1 = 0) Power amplifier working in high efficiency mode (D1 = 1) |
| D0 | Left Channel Power amplifier working in standard mode (D0 = 0) Power amplifier working in high efficiency mode (D0 = 1) |

If R/W = 1, the TDA7563PD sends 4 "Diagnostics Bytes" to μ P: DB1, DB2, DB3 and DB4.

Table 8. DB1

| | |
|----|---|
| D7 | Thermal warning active (D7 = 1) |
| D6 | Diag. cycle not activated or not terminated (D6 = 0) Diag. cycle terminated (D6 = 1) |
| D5 | X |
| D4 | Channel LF Turn-on diagnostic (D4 = 0) Permanent diagnostic (D4 = 1) |
| D3 | Channel LF Normal load (D3 = 0) Short load (D3 = 1) |
| D2 | Channel LF Turn-on diag.: No open load (D2 = 0) Open load detection (D2 = 1) Offset diag.: No output offset (D2 = 0) Output offset detection (D2 = 1) |
| D1 | Channel LF No short to Vcc (D1 = 0) Short to Vcc (D1 = 1) |
| D0 | Channel LF No short to GND (D1 = 0) Short to GND (D1 = 1) |

Table 9. DB2

| | |
|----|--|
| D7 | Offset detection not activated (D7 = 0) Offset detection activated (D7 = 1) |
| D6 | X |
| D5 | X |
| D4 | Channel LR Turn-on diagnostic (D4 = 0) Permanent diagnostic (D4 = 1) |
| D3 | Channel LR Normal load (D3 = 0) Short load (D3 = 1) |
| D2 | Channel LR Turn-on diag.: No open load (D2 = 0) Open load detection (D2 = 1) Permanent diag.: No output offset (D2 = 0) Output offset detection (D2 = 1) |
| D1 | Channel LR No short to Vcc (D1 = 0) Short to Vcc (D1 = 1) |
| D0 | Channel LR No short to GND (D1 = 0) Short to GND (D1 = 1) |

Table 10. B3

| | |
|----|--|
| D7 | Stand-by status (= IB1 - D4) |
| D6 | Diagnostic status (= IB1 - D6) |
| D5 | X |
| D4 | Channel RF Turn-on diagnostic (D4 = 0) Permanent diagnostic (D4 = 1) |
| D3 | Channel RF Normal load (D3 = 0) Short load (D3 = 1) |
| D2 | Channel RF Turn-on diag.: No open load (D2 = 0) Open load detection (D2 = 1) Permanent diag.: No output offset (D2 = 0) Output offset detection (D2 = 1) |
| D1 | Channel RF No short to Vcc (D1 = 0) Short to Vcc (D1 = 1) |
| D0 | Channel RF No short to GND (D1 = 0) Short to GND (D1 = 1) |

Table 11. DB4

| | |
|----|--|
| D7 | X |
| D6 | X |
| D5 | X |
| D4 | Channel RR Turn-on diagnostic (D4 = 0) Permanent diagnostic (D4 = 1) |
| D3 | Channel R RNormal load (D3 = 0) Short load (D3 = 1) |
| D2 | Channel RR Turn-on diag.: No open load (D2 = 0) Open load detection (D2 = 1) Permanent diag.: No output offset (D2 = 0) Output offset detection (D2 = 1) |
| D1 | Channel RR No short to Vcc (D1 = 0) Short to Vcc (D1 = 1) |
| D0 | Channel RR No short to GND (D1 = 0) Short to GND (D1 = 1) |

10.1 Examples of bytes sequence

1 - Turn-On diagnostic - Write operation

| | | | | | | | |
|-------|--------------------------|-----|-----------------|-----|-----|-----|------|
| Start | Address byte with D0 = 0 | ACK | IB1 with D6 = 1 | ACK | IB2 | ACK | STOP |
|-------|--------------------------|-----|-----------------|-----|-----|-----|------|

2 - Turn-On diagnostic - Read operation

| | | | | | | | | | | | |
|-------|--------------------------|-----|-----|-----|-----|-----|-----|-----|-----|-----|------|
| Start | Address byte with D0 = 1 | ACK | DB1 | ACK | DB2 | ACK | DB3 | ACK | DB4 | ACK | STOP |
|-------|--------------------------|-----|-----|-----|-----|-----|-----|-----|-----|-----|------|

The delay from 1 to 2 can be selected by software, starting from T.B.D. ms

3a - Turn-On of the power amplifier with 30dB gain, mute on, diagnostic defeat, CD = 2%.

| | | | | | | | |
|-------|--------------------------|-----|----------|-----|----------|-----|------|
| Start | Address byte with D0 = 0 | ACK | IB1 | ACK | IB2 | ACK | STOP |
| | | | X0000000 | | XXX1XX11 | | |

3b - Turn-Off of the power amplifier

| | | | | | | | |
|-------|--------------------------|-----|----------|-----|----------|-----|------|
| Start | Address byte with D0 = 0 | ACK | IB1 | ACK | IB2 | ACK | STOP |
| | | | X0XXXXXX | | XXX0XXXX | | |

4 - Offset detection procedure enable

| | | | | | | | |
|-------|--------------------------|-----|----------|-----|----------|-----|------|
| Start | Address byte with D0 = 0 | ACK | IB1 | ACK | IB2 | ACK | STOP |
| | | | XX1XX11X | | XXX1XXXX | | |

5 - Offset detection procedure stop and reading operation (the results are valid only for the offset detection bits (D2 of the bytes DB1, DB2, DB3, DB4).

| | | | | | | | | | | | |
|-------|--------------------------|-----|-----|-----|-----|-----|-----|-----|-----|-----|------|
| Start | Address byte with D0 = 1 | ACK | DB1 | ACK | DB2 | ACK | DB3 | ACK | DB4 | ACK | STOP |
|-------|--------------------------|-----|-----|-----|-----|-----|-----|-----|-----|-----|------|

- The purpose of this test is to check if a D.C. offset (2V typ.) is present on the outputs, produced by input capacitor with anomalous leakage current or humidity between pins.
- The delay from 4 to 5 can be selected by software, starting from T.B.D. ms

Figure 31. PowerSO36 (slug up) Mechanical Data & Package Dimensions

| DIM. | mm | | | inch | | |
|------|-----------|-------|--------|--------|-------|---------|
| | MIN. | TYP. | MAX. | MIN. | TYP. | MAX. |
| A | 3.25 | | 3.43 | 0.128 | | 0.135 |
| A2 | 3.1 | | 3.2 | 0.122 | | 0.126 |
| A4 | 0.8 | | 1 | 0.031 | | 0.039 |
| A5 | | 0.2 | | | 0.008 | |
| a1 | 0.030 | | -0.040 | 0.0011 | | -0.0015 |
| b | 0.22 | | 0.38 | 0.008 | | 0.015 |
| c | 0.23 | | 0.32 | 0.009 | | 0.012 |
| D | 15.8 | | 16 | 0.622 | | 0.630 |
| D1 | 9.4 | | 9.8 | 0.37 | | 0.38 |
| D2 | | 1 | | | 0.039 | |
| E | 13.9 | | 14.5 | 0.547 | | 0.57 |
| E1 | 10.9 | | 11.1 | 0.429 | | 0.437 |
| E2 | | | 2.9 | | | 0.114 |
| E3 | 5.8 | | 6.2 | 0.228 | | 0.244 |
| E4 | 2.9 | | 3.2 | 0.114 | | 1.259 |
| e | | 0.65 | | | 0.026 | |
| e3 | | 11.05 | | | 0.435 | |
| G | 0 | | 0.075 | 0 | | 0.003 |
| H | 15.5 | | 15.9 | 0.61 | | 0.625 |
| h | | | 1.1 | | | 0.043 |
| L | 0.8 | | 1.1 | 0.031 | | 0.043 |
| N | 10° (max) | | | | | |
| s | 8° (max) | | | | | |

OUTLINE AND MECHANICAL DATA

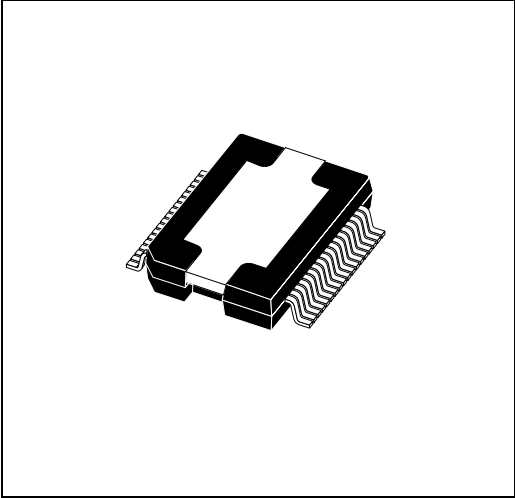

PowerSO36 (SLUG UP)

- (1) "D and E1" do not include mold flash or protrusions. Mold flash or protrusions shall not exceed 0.15mm (0.006")
- (2) No intrusion allowed inwards the leads.

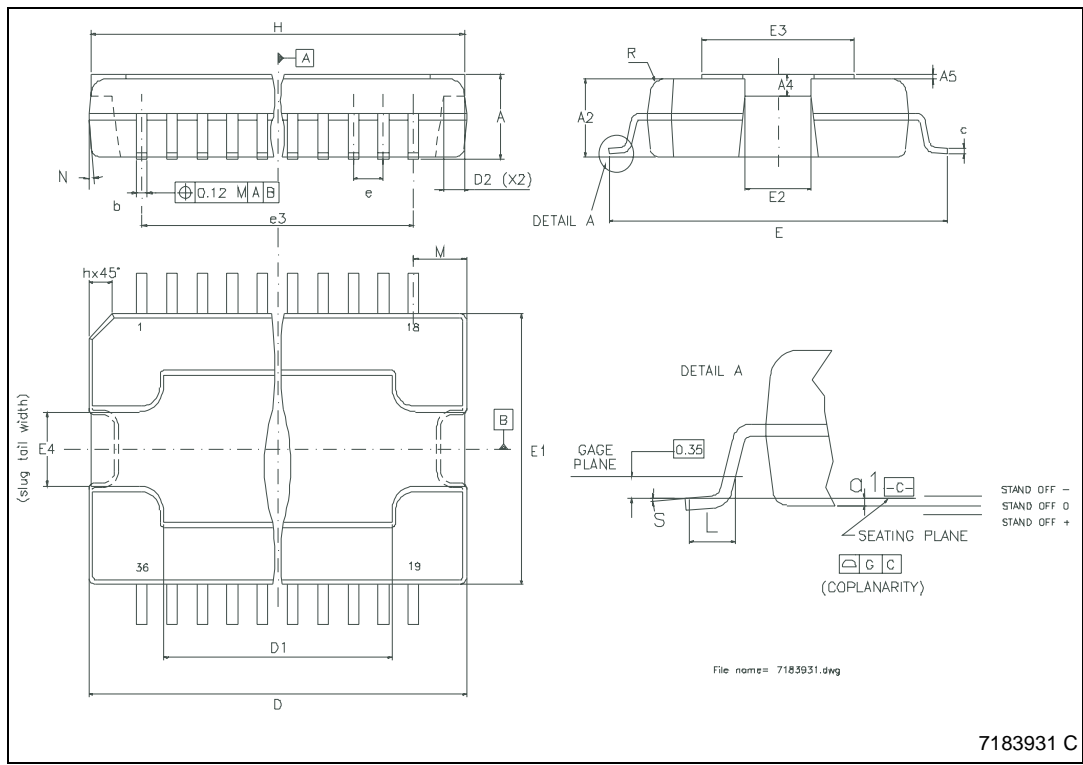

7183931 C

Table 12. Revision History

| Date | Revision | Description of Changes |
|------------|----------|------------------------|
| April 2004 | 1 | First Issue |

Information furnished is believed to be accurate and reliable. However, STMicroelectronics assumes no responsibility for the consequences of use of such information nor for any infringement of patents or other rights of third parties which may result from its use. No license is granted by implication or otherwise under any patent or patent rights of STMicroelectronics. Specifications mentioned in this publication are subject to change without notice. This publication supersedes and replaces all information previously supplied. STMicroelectronics products are not authorized for use as critical components in life support devices or systems without express written approval of STMicroelectronics.

The ST logo is a registered trademark of STMicroelectronics.
All other names are the property of their respective owners

© 2004 STMicroelectronics - All rights reserved

STMicroelectronics GROUP OF COMPANIES

Australia - Belgium - Brazil - Canada - China - Czech Republic - Finland - France - Germany - Hong Kong - India - Israel - Italy - Japan -
Malaysia - Malta - Morocco - Singapore - Spain - Sweden - Switzerland - United Kingdom - United States
www.st.com